

SYSclad

12-17,5-24 kV

25-31,5-40 kA



Medium voltage switchboard metal-clad type
Quadri di media tensione tipo metal-clad
Tableau de moyenne tension type metal-clad

SYSclad
12-17,5-24 kV
25-31,5-40 kA



Medium voltage switchboard metal-clad type
Quadri di media tensione tipo metal-clad
Tableau de moyenne tension type metal-clad

			Pag.
Generalities	Generalità	Généralités	02
Employment	Impiego	Emploi	03
Description	Descrizione	Description	04
Norms and homologations	Norme e certificati	Normes et certificats	08
Electrical features	Caratteristiche elettriche	Caractéristiques électriques	10
Typical panels	Pannelli tipici	Cellules typiques	11
Dimensional features, fixing and incoming cables	Caratteristiche dimensionali, fissaggio e passaggio cavi	Caractéristiques dimensionnelles, fixage et passage de câbles	14

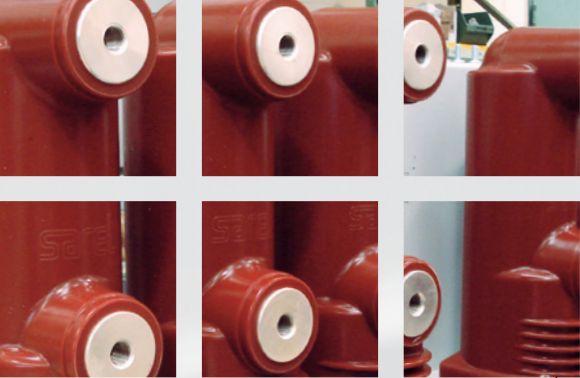

Generalities Generalità Généralités

SYSclad MV switchboard is composed by a standardized and modular series of panels *metal-clad* type (LSC-2B), equipped with withdrawable WL/r series encapsulated pole vacuum circuit breakers.

The functional compartments of the switchboard are granted for the internal arc execution according to the IEC 62271-200 standards, appendix AA, accessibility class A, criterion 1 to 5.

Complex switchboard configurations can be realized using modular panels.

Each panel and circuit is equipped with necessary mechanical interlocks to ensure maximum safety of the operator.

Arc-proof execution and high ingress protection allows these panels to be placed in extreme conditions.

Il quadro MT **SYSclad** è costituito da una serie normalizzata e modulare di scomparti tipici tipo *metal-clad* (LSC-2B), equipaggiati con interruttori automatici sottovuoto in esecuzione estraibile della serie WL/r.

Le unità funzionali del quadro sono garantite per la tenuta ad arco interno in accordo alle normative IEC 62271-200, appendice AA, accessibilità classe A, criterio dall'1 al 5.

La modularità degli scomparti permette di realizzare quadri anche con configurazioni complesse.

Ogni scomparto è corredato di interblocchi meccanici, che assicurano operazioni di manovra in condizioni di assoluta sicurezza.

L'esecuzione a tenuta d'arco interno ne consente l'impiego in condizioni di esercizio estreme.

Le tableau MT **SYSclad** est composé d'une série de cellules standards et modulaires type *metal-clad* (LSC-2B), équipées de disjoncteurs automatiques sous vide débrochables de la série WL/r.

Les unités fonctionnelles du tableau sont garanties pour la tenue à l'arc interne conformément à la norme IEC 62271-200, annexe AA, accessibilité classe A, critère de 1 à 5.

La modularité des cellules permis la réalisation même les configurations les plus complexes.

Chacune d'entre elle est équipée avec des verouillages mécaniques qui assurent toute sécurité lors de manoeuvres.

La tenue à l'arc interne permet d'utiliser ces cellules même en conditions d'exercices extrêmes.



Employment Impiego Emploi

SYSclad air insulated switchboards equipped with vacuum circuit breaker, are suitable for the primary distribution networks.

They can be employed in power stations, HV/MV substations, industries and in other special applications.

I quadri **SYSclad** isolati in aria equipaggiati con interruttori sottovuoto, sono adatti per l'utilizzo nelle reti di distribuzione primaria.

In particolare possono essere impiegati nelle stazioni di potenza, nelle sottostazioni AT/MT nelle industrie e in applicazioni speciali.

Les tableaux **SYSclad** sont équipés de disjoncteurs automatiques sous vide et peuvent être utilisés pour la distribution électrique primaire.

Ils peuvent être utilisés dans les sous stations de puissance, les sous station HT/MT, les usines ainsi que dans les applications spéciales.





Description

Descrizione

Description

1

Auxiliary compartment
Cassonetto ausiliario
Coffret auxiliaire

3

Circuit breaker compartment
Vano interruttore
Compartment disjoncteur

2

Main bus bars compartment
Vano sbarre principali
Compartment barres principales

4

Feeder/Cable and CT compartment
Vano cavi e TA
Compartment câbles et TC

5

Voltage transformers compartment
Vano trasformatori di tensione
Compartment transformateurs de tension

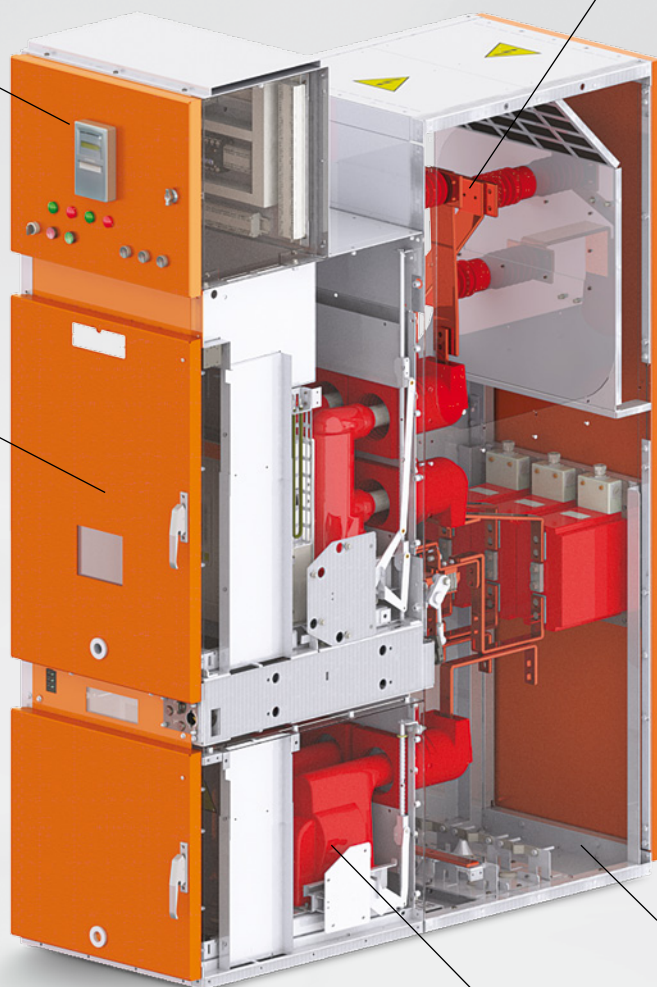

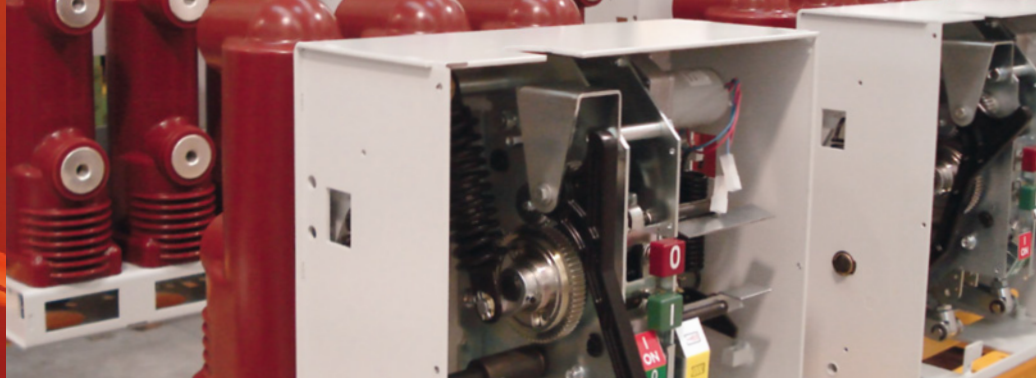

Auxiliary compartment Cassonetto ausiliario Coffret auxiliaire

1



This compartment is used to set the auxiliary command and control equipments, such as protection relay, control buttons, signaling lamps, terminal boards, etc..

Questo scomparto viene utilizzato per collocare le apparecchiature ausiliarie per il comando e controllo, come relè di protezione, pulsanti, lampade di segnalazione, morsettiere di collegamento, ecc..

Ce compartiment est utilisé pour placer les équipements auxiliaires de commande et de contrôle comme le relai de protection, les boutons-poussoirs, les lampes de signalisation et les bornes pour connexions, etc..

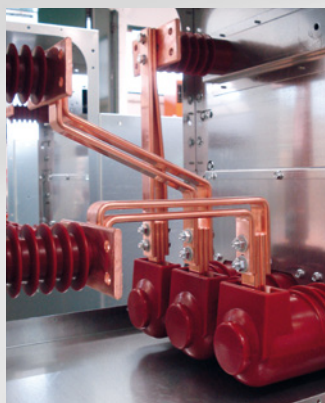

In the bus bars compartment are placed the three main bus bars of the system.

The bus bars can have rated current up to 3150A.

Main bus bars compartment Vano sbarre principali Compartment barres principales

2

Nel vano sbarre trovano collocamento le sbarre principali del sistema.

Le sbarre possono avere corrente nominale fino a 3150A.

Dans ce compartiment sont colloquées les trois barres principales du système qui peuvent supporter un courant nominal pouvant attendre les 3150A.

Circuit breaker compartment Vano interruttore Compartment disjoncteur

3



The MV vacuum circuit breaker WL/r encapsulated type is fully withdrawable, the CB can only be racked out of the switchgear only when the door is closed, for the maximum safety. Thanks to a special production process, it ensures high performances under all service conditions.

The vacuum interrupter is embedded in resin during the molding stage, improving dielectric strength.

L'interruttore sottovuoto della serie WL/r è equipaggiato di carrello che ne consente l'estraibilità e l'inserzione solo a porta chiusa, per garantire la massima sicurezza. Grazie ad un particolare processo di produzione, assicura elevate performance in qualsiasi condizione di servizio.

L'ampolla sottovuoto è inglobata nella resina direttamente durante la fase di stampaggio, migliorandone la tenuta dielettrica.

Le disjoncteur sous vide MT type WL/r est équipé d'un charriot qui lui permet d'être plus modulable (insertion et extraction) toute en gardant la porte fermée. Grâce à un particulier processus productif, il assure des performance très élevées dans toutes conditions de service.

L'ampoule sous vide qui est incorporée dans la résine directement dans la phase de moulage, améliore la tenue diélectrique.



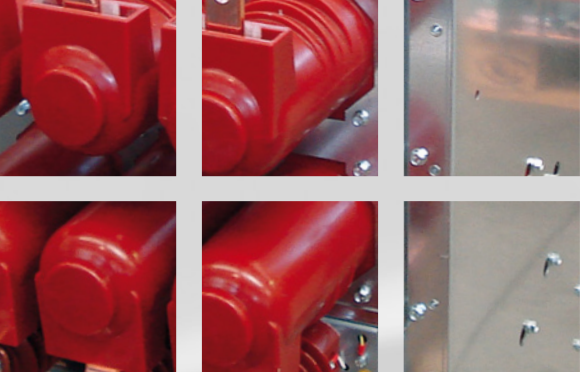

4

Feeder/Cable and CT compartment Vano cavi e TA Compartment câble et TC

The feeder compartment houses the branch connection system to connect the power cables and the CT to provide the signal to the protection relay; the connections are made of electrolytic copper.

Each incoming/outgoing feeder unit can be fitted with an earthing switch to earth the cables.

Il questo compartimento viene alloggiato il sistema di connessione per il collegamento dei cavi di potenza, nonché i TA che portano i segnali di corrente ai relé di protezione; le connessioni sono realizzate in rame elettrolitico.

Tutte le unità di ingresso/uscita possono essere equipaggiate con un sezionatore di terra per mettere a terra i cavi.

Dans cet compartiment est placé le système de connexion des câbles de puissance ainsi que les TC qui acheminent le signal au relais de protection. Toutes les connexions sont réalisées avec du cuivre électrolytique.

Toutes les unités arrivée/départ peuvent être équipées d'un sectionneur de mise a la terre qui sert à la mise a la terre des câbles.

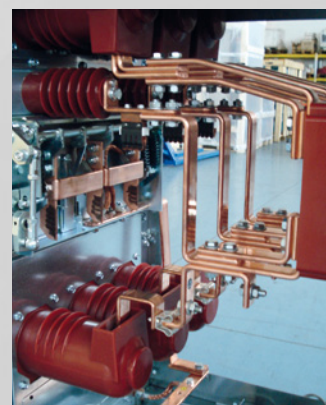

5

Voltage transformers compartment Vano trasformatori di tensione Compartiments transformateurs de tension

In this compartment are houses the voltage transformer to provide the signal to the metering and protection instruments.

They are available either for fixed installation or mounted on withdrawable trucks.

They can have one or two poles with performances and classes of precision suited to the functional requirements of the instrument connected to them.

Nello scomparto sono posizionati i trasformatori di tensione in resina, impiegati per fornire il segnale agli strumenti di misura e di protezioni.

Sono disponibili sia per installazione fissa che per montaggio su carrello estraibile.

Possano avere uno o due secondari con classe di precisione e potenze adatte ai requisiti funzionali degli strumenti connessi.

Dans cet compartiment sont placé les transformateurs de potentiel qui acheminent le signal aux instruments de mesure et protection.

Ils sont disponible pour desinstallation fixes ou avec charriot débrochables et peuvent avoir un ou deux pôles avec classe de précision et de puissances compatibles au caractéristiques fonctionnelles des instruments connectés.



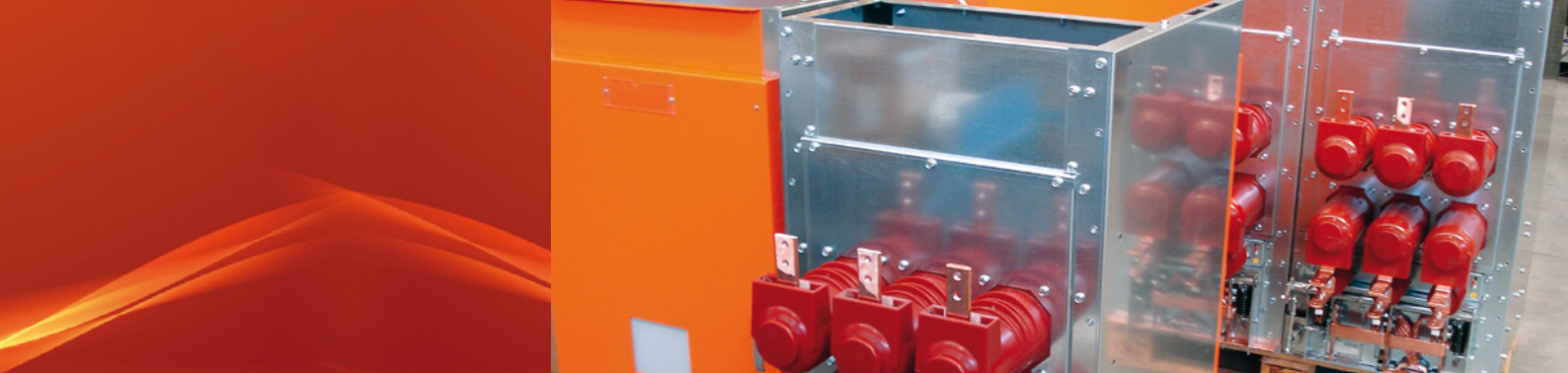

Completion equipment Equipaggiamenti di completamento Équipement d'achèvement

Voltage transformers Trasformatori di tensione Transformateurs de tension



They are insulated in epoxy resin, are used to provide the signal for both measuring and protection instruments.
They can be either fixed with or without protection fuses or mounted on a withdrawable trolley. When they are installed on the withdrawable trolley, the transformers are protected by fuses. They can be isolated safely also when the switchboard is in service.

Isolati in resina epossidica, servono per fornire il segnale agli strumenti di misura e di protezione.
Possono essere in versione fissa oppure montati su carrello estraibile ed avere oppure no il fusibile di protezione. Quando equipaggiati di carrello estraibile possono essere estratti in tutta sicurezza anche con il quadro in servizio.

Ils sont isolés dans la résine époxydique et servent à fournir les signaux nécessaires aux instruments de mesure et de protection. Ils peuvent être en version fixe ou montés sur un chariot débrochable et peuvent être équipés de fusibles de protection. Lorsqu' ils sont installés sur un chariot, ils peuvent être manipulés sans danger toute en gardant le tableau toujours en service.

Current transformers Trasformatori di corrente Transformateurs de courant



They are manufactured in compliance with DIN / IEC standards and provide the signal to the various protection and measurement devices.
They are insulated in epoxy resin and can satisfy various configurations. They may have one or two primary windings and up to three secondary windings.

Sono costruiti in accordo alle norme DIN/IEC e forniscono il segnale ai vari apparecchi di misura e protezione. Sono isolati in resina epossidica e possono soddisfare le più svariate configurazioni. Possono avere infatti uno o due rapporti primari e fino a tre rapporti secondari.

Fabriqués selon les normes DIN/ IEC et ils sont isolés dans la résine époxydique et servent à fournir les signaux nécessaires aux instruments de mesure et protection. Avec un ou deux rapports primaires et jusqu'à trois rapports secondaires, ces derniers permettent de satisfaire aux besoins des configurations plus complexe.



They are used for the protection of the voltage transformers. Are in accordance with DIN standards.

Vengono utilizzati per la protezione dei trasformatori di tensione. Sono prodotti in accordo alle norme DIN.

Fabriqué selon les normes DIN, ils son utilisés pour la protection des transformateurs de tension.

**Fuses
Fusibili
Fusibles**



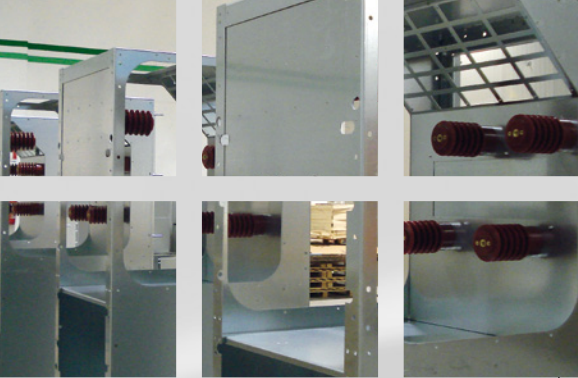

Norms and homologations

Norme e certificati

Normes et certificats

SYSclad switchboards have positively passed all type tests at official laboratories (CESI), according to the International Standards IEC, as well as they have obtained the peculiar homologations in others countries.

The quality system (ISO 9001 – ISO 14000) assures that the overall production process is maintained at high and consistent quality level.

During the complete cycle of production each equipment is submitted to electrical and mechanical tests until the final test, performed as required by the IEC Standards.



Standards

(IEC) CEI EN-62271-200
 (IEC) CEI EN-62271-102
 (IEC) CEI EN-62271-100
 CEI 0-16



I quadri **SYSclad** hanno positivamente superato, presso laboratori ufficiali (CESI), tutte le prove di tipo, in accordo alle Norme Internazionali IEC, oltre che aver ottenuto omologazioni specifiche di altri paesi.

Il sistema di controllo qualità (ISO 9001 – ISO 14000) assicura che l'intero processo di produzione mantenga un livello qualitativamente alto e costante.

Durante tutto il ciclo di produzione le apparecchiature sono sottoposte a prove meccaniche ed elettriche fino al collaudo finale, condotto secondo quanto previsto dalle Normative IEC.

Norme

(IEC) CEI EN-62271-200
 (IEC) CEI EN-62271-102
 (IEC) CEI EN-62271-100
 CEI 0-16



Les tableaux **SYSclad** ont positivement passé tous les contrôles dans les laboratoires officiels (CESI), tous les essais de type sont en accord aux Normes Internationales IEC, et ont obtenu aussi les homologations spécifiques dans plusieurs pays à travers le monde.

Le système de contrôle qualité (ISO 9001 – ISO 14000) assure que tout le processus de production garde un niveau qualitativement haut et constant.

Pendant tout le cycle de production les équipements sont soumis aux essais électriques et mécaniques jusqu'à l'essai final, réalisé en conformité aux Normes IEC.

Normes

(IEC) CEI EN-62271-200
 (IEC) CEI EN-62271-102
 (IEC) CEI EN-62271-100
 CEI 0-16

Technical features

Caratteristiche tecniche

Caractéristiques techniques



Due to continuous development of building materials and the updating of standards, reported data are not constricting and are subject to our revision.

Considerando l'evoluzione di materiali e norme, quanto riportato nel presente documento si potrà ritenere impegnativo solo dopo nostra conferma.

Etant donné l'évolution des matériels ainsi que des normes, les informations contenues dans le présent document, ne seront considérées comme étant valable qu'après confirmation de notre part.

Electrical features

Caratteristiche elettriche

Caractéristiques électriques



SYSciad switchboard
Quadro SYSciad
Tableau SYSciad

SYSciad				
Rated voltage Tensione nominale Tension nominale	kV	12	17.5	24
Rated power-frequency withstand voltage 50Hz 1Min (kV r.m.s.) Tensione nominale di tenuta alla frequenza di esercizio 50Hz 1Min (kV eff.) Tension nominale à la fréquence industrielle 50Hz 1Min (kV eff.)	kV	To earth and between phases Verso massa e tra le fasi Vers la terre et entre les phases	28	38
		Across the isolating distance Sulla distanza di sezionamento Sur la distance de sectionnement	32	45
Rated lightning impulse withstand voltage (peak value) Tensione nominale di tenuta ad impulso atmosferico (valore di picco) Tension nominale de tenue au choc (valeur de crête)	kV	To earth and between phases Verso massa e tra le fasi Vers la terre et entre les phases	75	95
		Across the isolating distance Sulla distanza di sezionamento Sur la distance de sectionnement	85	110
Rated frequency Frequenza nominale Fréquence nominale	Hz	50-60		
Rated current main bus bars up to Corrente nominale sbarre principali fino a Courant nominale barres principales jusqu'à	A	3150		2500
Rated current unit Corrente nominale unità funzionali Courant nominale unité fonctionnelles	A	630 1250 1600 2000 2500 3150	630 1250 1600 2000 2500	
Short-time withstand current Corrente di breve durata ammissibile Courant de courte durée admissible	kA-s	25-3s 31,5-3s 40-3s*	25-3s 31,5-3s**	
Peak value Valore di picco Valeur de crête	kA	62,5 80 100*	62,5 80**	
Withstand internal arc Tenuta a l'arco interno Tenue à l'arc interne	kA-s	25-3s		
Protection degree indoor / outdoor Grado di protezione interno / esterno Degré de protection intérieur / extérieur	IP	2X / 3X		
Altitude Altitudine Hauteur	m	≤1000		
Ambient temperature Temperatura ambiente Température ambiante	°C	-5÷40		

* Available for versions 2500-3150A | Disponibile per versioni 2500-3150A | Disponible pour versions 2500-3150A

** Available for versions 1600-2000-2500A | Disponibile per versioni 1600-2000-2500A | Disponible pour versions 1600-2000-2500A

Incoming/Outgoing Bus-Tie Arrivo/Partenza Congiuntore Arrivée/Depart Conjoncteur

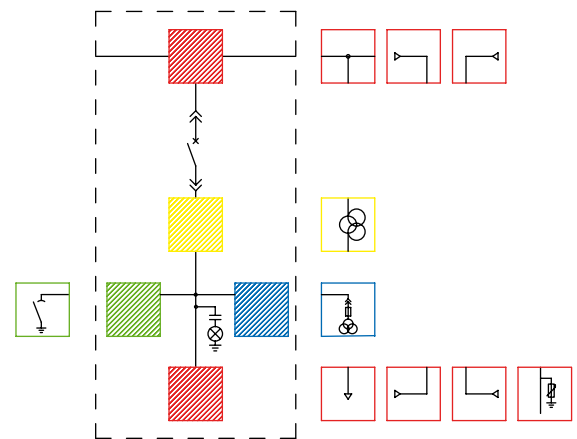
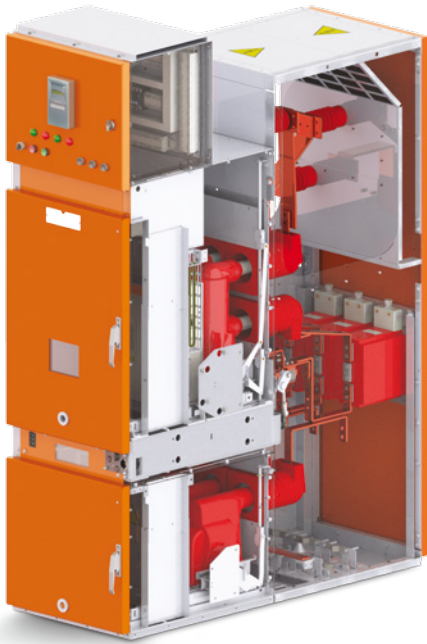

Basic equipment

- Bus bars
- Encapsulated pole circuit breaker
- Motor operating mechanism for automatic circuit breaker
- Voltage indicators
- Microprocessor secondary protection
- Heater resistance with thermostat
- Low voltage auxiliary compartment

Optional accessories

- Earth switch
- Voltage Transformers
- Current Transformers
- Surge Arrester

Equipaggiamento di base

- Sistema di sbarre
- Interruttore automatico
- Comando a motore per interruttore automatico
- Indicatori di presenza tensione
- Protezione secondaria a microprocessore
- Resistenza anticondensa con termostato
- Cassonetto circuiti ausiliari

Accessori a richiesta

- Sezionatore di messa a terra
- Trasformatori di tensione
- Trasformatori di corrente
- Scaricatore

Equipement de base

- Jeu de barres
- Disjoncteur WL/r
- Commande motorisée pour Disjoncteur
- Indicateurs de tension
- Protection secondaire à microprocesseur
- Résistance de chauffage avec thermostat
- Coffret pour circuit auxiliaires

Accessories en option

- Sectionneur de m.a.t.
- Transformateurs de tension
- Transformateurs de courant
- Parafoudre

Direct Incoming/Outgoing Bus-Riser Arrivo/Partenza Diretta Risalita Arrivée/Depart Direct Remontée

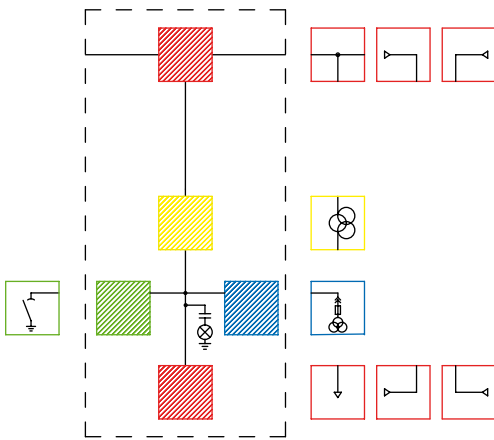

Basic equipment

- Bus bars
- Voltage indicators
- Heater resistance with thermostat
- Low voltage auxiliary compartment

Optional accessories

- Earth switch
- Voltage Transformers
- Current Transformers

Equipaggiamento di base

- Sistema di sbarre
- Indicatori di presenza tensione
- Resistenza anticondensa con termostato
- Cassonetto circuiti ausiliari

Accessori a richiesta

- Sezionatore di messa a terra
- Trasformatori di tensione
- Trasformatori di corrente

Equipement de base

- Jeu de barres
- Indicateurs de tension
- Résistance de chauffage avec thermostat
- Coffret pour circuit auxiliaires

Accessories en option

- Sectionneur de m.a.t.
- Transformateurs de tension
- Transformateurs de courant

Metering with VT Misure con TV Mesure avec TP

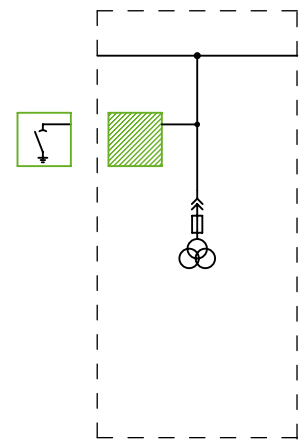

Basic equipment

- Bus bars
- Voltage indicators
- Voltage Transformers
- Heater resistance with thermostat
- Low voltage auxiliary compartment

Optional accessories

- Earth switch

Equipaggiamento di base

- Sistema di sbarre
- Indicatori di presenza tensione
- Trasformatori di tensione
- Resistenza anticondensa con termostato
- Cassonetto circuiti ausiliari

Accessori a richiesta

- Sezionatore di terra

Equipement de base

- Jeu de barres
- Indicateurs de tension
- Transformateurs de tension
- Résistance de chauffage avec thermostat
- Coffret pour circuit auxiliaires

Accessories en option

- Sectionneur de m.a.t.

12-17,5kV

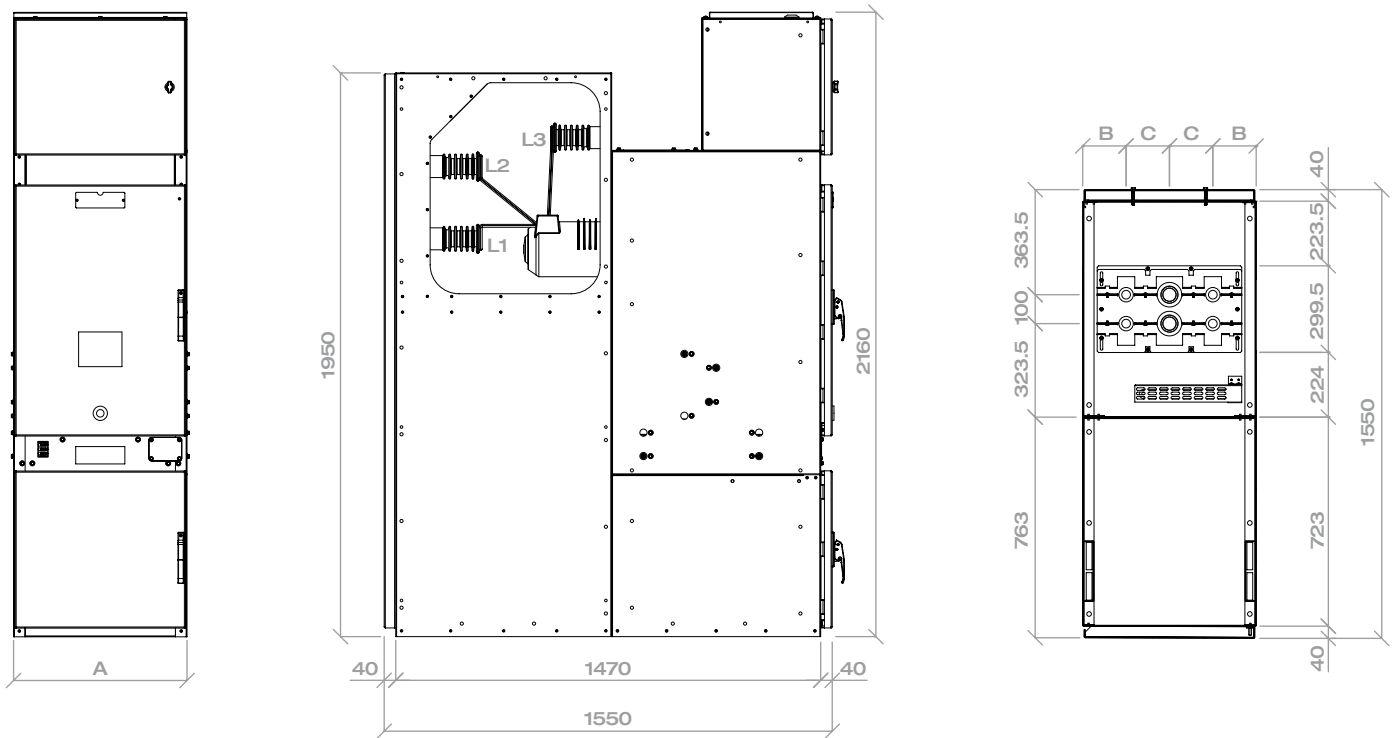

Dimensions | Dimensioni | Dimensions

kV	Amp	mm		
		A	B	C
12	630-1250A	600	150	150
	1600-2000A	750	165	210
	2500-3150A	1000	225	275
17,5	630-1250A	600	150	150
	1600-2000A	750	165	210
	2500-3150A	1000	225	275

Panel weight | Pesi dei pannelli | Poids de cellule

Type	12-17,5kV		
	600mm	750mm	1000mm
	400-450 kg	450-500 kg	550-600 kg

The weights are indicated in kg | I pesi sono espressi in kg |
 Les poids sont indiqués en kg

24 kV

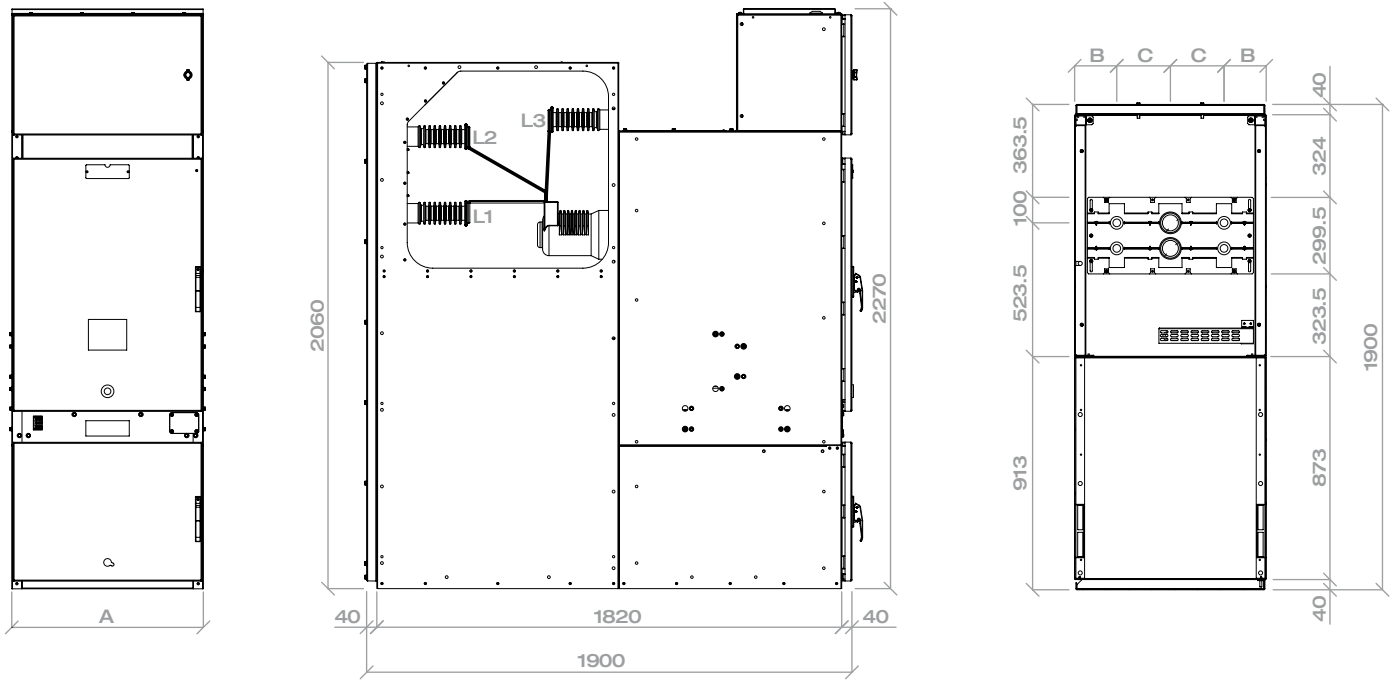

Dimensions | Dimensioni | Dimensions

kV	Amp	mm		
		A	B	C
24	630-1250A	750	165	210
	1600-2000-2500A	1000	225	275

Panel weight | Pesì dei pannelli | Poids de cellule

Type	24 kV	
	750mm	1000mm
	500-550 kg	600-650 kg

The weights are indicated in kg |
 I pesi sono espressi in kg | Les poids sont indiqués en kg



For energizing the world

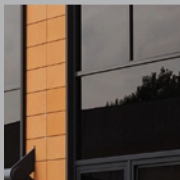
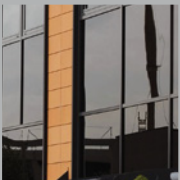
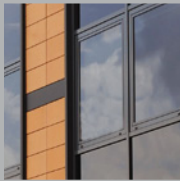



Via del Commercio, 12/14
26900, Lodi (LO), Italy

Tel. +39 0371 49061
Fax +39 0371 411422

info@sarel.it
www.sarel.it